

Cadenas de sûreté / TYPE 1

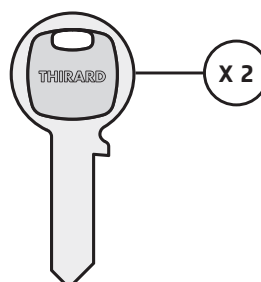

Acier
cémenté



Laiton

Description / Description / Descripción

Corps laiton monobloc. Anse acier cémenté nickelé. Mécanisme à goupilles. Double ancrage. 2 clés acier nickelé.

Compact brass body. Hardened nickel plated steel shackle. Pin mechanism. Double locking. 2 nickel plated steel keys.

Cuerpo de latón monobloque. Arco de acero cementado niquelado. Mecanismo de pasadores. Doble anclaje. 2 llaves de acero niquelado. Acabado Latón pulido.

Finition / Finish / Acabado

Laiton poli
Polished brass
Latón pulido

Version / Option / Versión

Anse demi haute et haute pour taille 40 mm. Anse haute pour taille 45. Clés supplémentaires sur modèle. Sans fabrication sur numéro imposé. Cadenas sur même combinaison pour taille 30, 35, 40, 45, 50 mm.

Demi long shackle and long shackle for size 40 mm.

Long shackle for size 45. Extra keys with model.

Without manufacturing under request number. Keyed alike padlocks for size 30, 35, 40, 45, 50 mm available.

Arco semialto y alto para tamaño 40 mm

Arco alto para tamaños 45

Llaves suplementarias sobre modelo

Sin fabricación con número impuesto

Candado con la misma combinación para tamaños 30, 35, 40, 45, 50 mm

Utilisation / Use / Utilización

Intérieur

Indoor

Interior



Designation	Boite	Colis.	Prix	Bac	Colis.	Prix	Blister				Colis.	Prix
							France	Euro 1	Euro 2	Euro 3		
TYPE 1 • 30 mm *	0800302	10	5,44	9800303	20	5,87	1800301	1930039	1920030 9920032 sachet	1940038	10 10	6,39 5,87
TYPE 1 • 35 mm *	0800357	10	6,64	9800358	20	7,28	1800356	1930060	1920061 9920063 sachet	1940069	10 10	7,77 7,28
TYPE 1 • 40 mm	0800401	10	7,76	9800402	20	8,52	1800400	1930084	1920085 9920087 sachet	1940083	10 10	8,75 8,52
TYPE 1 • 40 mm anse 1/2 haute	0806403	10	9,27	9806404	20	10,62	1806402	1930091	1920092	1940090	10	11,04
TYPE 1 • 40 mm anse haute	0800425	10	9,90	-	-	-	2800423	2930106	2920107	2940105	10	11,99
TYPE 1 • 45 mm	0800456	10	10,40	9800457	20	11,39	1800455	1930121	1920122 9920124 sachet	1940120	10 10	12,03 11,39
TYPE 1 • 45 mm anse haute	0800470	10	11,79	-	-	-	2800478	2930137	2920138	2940136	10	14,79
TYPE 1 • 50 mm	0800500	10	13,17	9800501	20	14,40	1800509	1930152	1920153 9920155 sachet	1940151	10 10	15,21 14,40

* Simple ancrage / Simple locking / Simple anclaje

Cadenas de sùreté / TYPE 1



Ouverture de 2 ou 3 cadenas avec môme clé

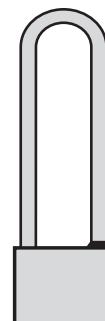
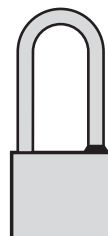

	30mm	35mm	40mm	45mm	50mm	40mm	40mm	45mm
	30	35	40	45	50	40	40	45
	27	30	33	38	42	33	33	38
	14	14,5	14,5	15,5	17	14,5	14,5	15,5
	18	20	22	24	26	58	130	125
	15	19	21	25	25	21	21	29
	5,5	5,5	6	7	9	6	6	7
Goup.	4	4	5	5	5	5	5	5

Designation	Boite	Colis.	Prix	Bac	Colis.	Prix	Blister				Colis.	Prix
							France	Euro 1	Euro 2	Euro 3		
Jeu de 2 cadenas TYPE 1 • 30 mm * s'ouvrant 4 clés				9802307	20	11,64	1802305	1930046	1920047	1940045	10	12,77
Jeu de 3 cadenas TYPE 1 • 30 mm * s'ouvrant 6 clés							2800300	2930052	2920053	2940051	5	19,16
Jeu de 2 cadenas TYPE 1 • 35 mm * s'ouvrant 4 clés							1800349				10	15,33
Jeu de 3 cadenas TYPE 1 • 35 mm * s'ouvrant 6 clés							2800355	2930076	2920077	2940075	5	22,80
Jeu de 2 cadenas TYPE 1 • 40 mm s'ouvrant 4 clés							1800448	1930114	1920115	1940113	10	16,78
Jeu de 3 cadenas TYPE 1 • 40 mm s'ouvrant 6 clés							2803400				5	25,73
Jeu de 2 cadenas TYPE 1 • 45 mm s'ouvrant 4 clés							1802459	1930145	1920146	1940144	10	23,61
Jeu de 3 cadenas TYPE 1 • 45 mm s'ouvrant 6 clés							2800454				5	35,38
Lots «PROMO»												
Jeu de 2 cadenas TYPE 1 • 30 mm s'ouvrant 4 clés + Cad. Basic 30mm							1803302	1803302	1803302	1803302	10	17,03
Jeu de 2 cadenas TYPE 1 • 30 mm s'ouvrant 4 clés + Mousqueton							1802398	1802398	1802398	1802398	10	13,92

* Simple ancrage / Simple locking / Simple anclaje



556830



556831

Caractéristiques certifiées NF :
endurance, durabilité, sécurité.



Spécifications dimensionnelles
selon la norme NF P 26-414
Essais selon la norme NF EN 12209
Classification

3 B 4 0 0 0 3 H C 3 0

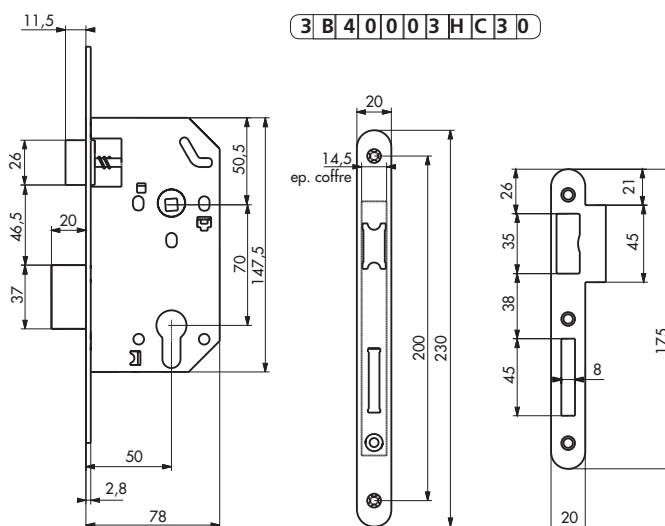

Description / Description / Descripción

Coffre acier embouti. Têtière acier bouts ronds. Demi-tour bipente alliage réversible sans démontage du coffre. Pêne acier galvanisé. Gâche plate acier zingué. Mécanisme à 2 tours. Rappel du 1/2 tour par la clé.
□ 7 mm, entr'axe 70 mm.

Stamped steel case. Round ended steel forend. Reversible alloy latch without removing the case. Galvanised steel bolt. Zinc plated steel flat striker. Double deadbolt throw. Draw back of the latch by key.
□ 7 mm.

Caja de acero embutido. Cabeza de extremos redondos. Media vuelta de aleación reversible sin desmontar la caja. Pestillo de acero galvanizado. Cerradero plano de acero cincado. Mecanismo de 2 vueltas. Reposición de la media vuelta con la llave. □ 7 mm.

Finition / Finish / Acabado

Coffre galvanisé, tèteière epoxy noir granité.
Case galvanised, forend black epoxy.
Caja galvanizado, cabeza epoxy negro.

Version / Option / Versión

Tèteière inox, acier laitoné, acier nickelé.
Possibilité □ 8 mm sur demande.
Stainless steel forend, brass plated forend, nickel plated forend. □ 8 mm on request.
Cabeza de acero inoxidable, acero latonado, acero niquelado. □ 8 mm a petición.

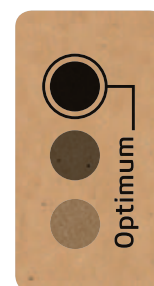

Designation	Boite	Colis.	Prix	Bac	Colis.	Prix	Blister				Colis.	Prix
							France	Euro 1	Euro 2	Euro 3		
BOÎTIER MONOMAX NF têteière noire	5568306	5	11,41	-	-	-	4568307				5	15,35
BOÎTIER MONOMAX NF têteière inox	5568313	5	16,46	-	-	-	4568314				5	20,38
BOÎTIER MONOMAX NF têteière acier laitoné	5568320	5	14,47	-	-	-	-				-	-
BOÎTIER MONOMAX NF têteière acier nickelé	5568337	5	14,23	-	-	-	-				-	-

TARIF CONDITIONNEMENT NON DÉCOLISABLE

	Boite	Colis.	Prix
BOITIER SERRURE NORME N.F à cylindre réversible BR sans gâche	0568301	25	8,75
GACHE acier pour serrure NORME N.F à cylindre	0461022	25	0,58
BOITIER SERRURE NORME N.F à cylindre réversible BR têteière inox sans gâche	0568318	25	11,46
GACHE inox pour serrure NORME N.F à cylindre	0461039	25	2,57

Axe à 40 mm / À CONDAMNATION

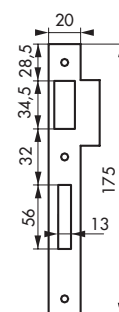
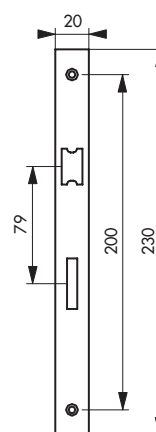
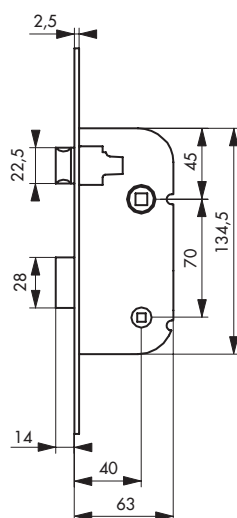

Description / Description / Descripción

Coffre acier embouti. Tête à acier. Demi-tour alliage réversible sans démontage du coffre. Pêne acier. Gâche plate acier. □ 7 mm, entr'axe 70 mm.
 Stamped steel case - Steel forend. Reversible alloy latch without removing the case. Steel bolt. Steel flat striker - □ 7 mm.

Caja de acero embutido. Cabeza de acero. Media vuelta de aleación reversible sin desmontar la caja. Pestillo de acero. Cerradero plano de acero - □ 7 mm.

Finition / Finish / Acabado

Epoxy blanc (V) - Zingué blanc (ZB)
 White epoxy (V) - White zinc plated (ZB)
 Epoxi blanco (V) - Cincado blanco (ZB)

Version / Option / Versión

Tête à bouts carrés (BC) - Tête à bouts ronds (BR)
 Square (BC) - Round (BR) ended forend
 Cabeza de extremos cuadrados (BC) - Cabeza de extremos redondos (BR)

Utilisation / Use / Utilización

Porte isoplane < 40 kg, (NON GARANTIE EN CAS DE CONTRE BEQUILLAGE)
 Door < 40 kg
 Puerta < 40 kg

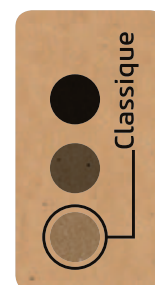

Designation	Boite	Colis.	Prix	Bac	Colis.	Prix	Blister				Colis.	Prix
							France	Euro 1	Euro 2	Euro 3		
SERRURE réversible V/BC	-	-		-	-		4001019				10	9,62
SERRURE réversible V/BR	-	-		9011013	30	6,22	4011018				10	9,62
SERRURE réversible ZB/BR	-	-		-	-		4111015				10	9,54

TARIF CONDITIONNEMENT NON DÉCOLISABLE

	Boite	Colis.	Prix
SERRURE axe à 40 mm à condamnation V/BR sans gâche droite	0811117	50	3,67
SERRURE axe à 40 mm à condamnation V/BR sans gâche gauche	0811216	50	3,67
GACHE type ECO	0810035	50	0,38

Serrure applique horizontale / PÊNE DORMANT

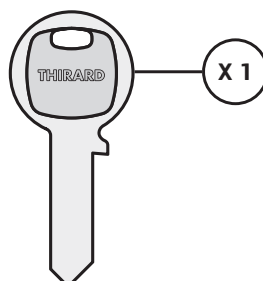
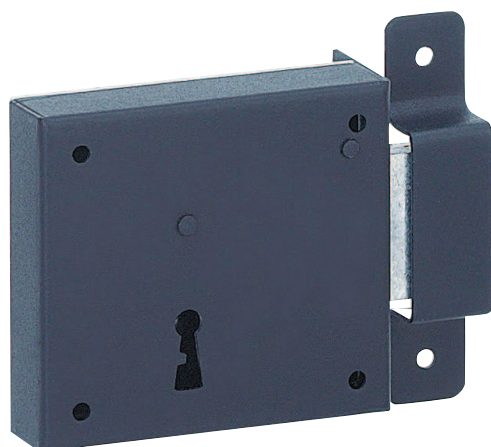

	85x76	95x76	110x80	140x80	160x80
A	85	95	110	140	160
B	67	74	89	120	140
C	50	60	60	80	105
D	76	76	80	80	80

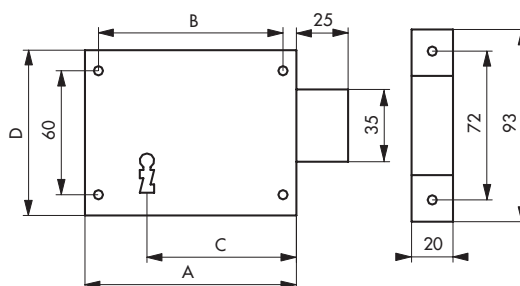

Description / Description / Descripción

Coffre en acier cambré. Gâche à pattes acier cambré.
Pêne alliage. Canon acier long. 35 mm. 1 clé polie.
6 variures.
*Cambered steel case. Cambered steel striker. Alloy bolt.
35 mm steel bush. 1 key. 6 key differs.*
Caja de acero curvado. Cerradero de patillas de acero
curvado. Pestillo de aleación. Cañón de acero, long.
35 mm. 1 llave pulida. 6 perfiles de llave.

Finition / Finish / Acabado

Epoxy noir granité
Granited black epoxy
Epoxi negro granitado

Version / Option / Versión

Droite et gauche
Right and left hand
Derecha e izquierda



Designation	Boite	Colis.	Prix	Bac	Colis.	Prix	Blister				Colis.	Prix
							France	Euro 1	Euro 2	Euro 3		
SERR. pêne dormant 85 x 76 mm drte	0031171	1	12,64	-	-		3031178				5	16,71
SERR. pêne dormant 85 x 76 mm gche	0031270	1	12,64	-	-		3031277				5	16,71
SERR. pêne dormant 95 x 76 mm drte	0021172	1	13,44	9021173	5	15,56	3021179				5	17,56
SERR. pêne dormant 95 x 76 mm gche	0021271	1	13,44	9021272	5	15,56	3021278				5	17,56
SERR. pêne dormant 110 x 80 mm drte	0011173	1	14,29	9011174	5	16,46	3011170				5	18,46
SERR. pêne dormant 110 x 80 mm gche	0011272	1	14,29	9011273	5	16,46	3011279				5	18,46
SERR. pêne dormant 140 x 80 mm drte	0001174	1	17,42	9001175	5	19,92	3001171				5	21,92
SERR. pêne dormant 140 x 80 mm gche	0001273	1	17,42	9001274	5	19,92	3001270				5	21,92
SERR. pêne dormant 160 x 80 mm drte	0139013	1	47,16	-	-		5139018				5	54,94
SERR. pêne dormant 160 x 80 mm gche	0139020	1	47,16	-	-		5139025				5	54,94

